

INSTALLATION INSTRUCTIONS

CAT 962G WHEEL LOADER

HAMMOND AIR CONDITIONING LTD
INGERSOLL, ONT.
1-800-267-2665
1-888-267-3745 (FAX)

CAT 962G INSTRUCTIONS

EVAPORATOR COIL:

The evaporator coil goes alongside the heater core in the heater blower assembly beside the operator's location.

1. Remove the housing from around the heater unit behind the seat.
2. Open the top to the heater box and remove the insert plate between the heater and the blower motors. This is held in place with 8 M6 bolts.
3. Remove the drain tube plugs if present.
4. Insert the evaporator coil and bolt in place using the original hardware.
NOTE For ease of alignment loosen or remove the box mounting bolts on either side of the evaporator coil.
5. Reassemble the top of the evaporator/blower box.
6. Install the thermostat and insert the probe 6" into the hole provided.

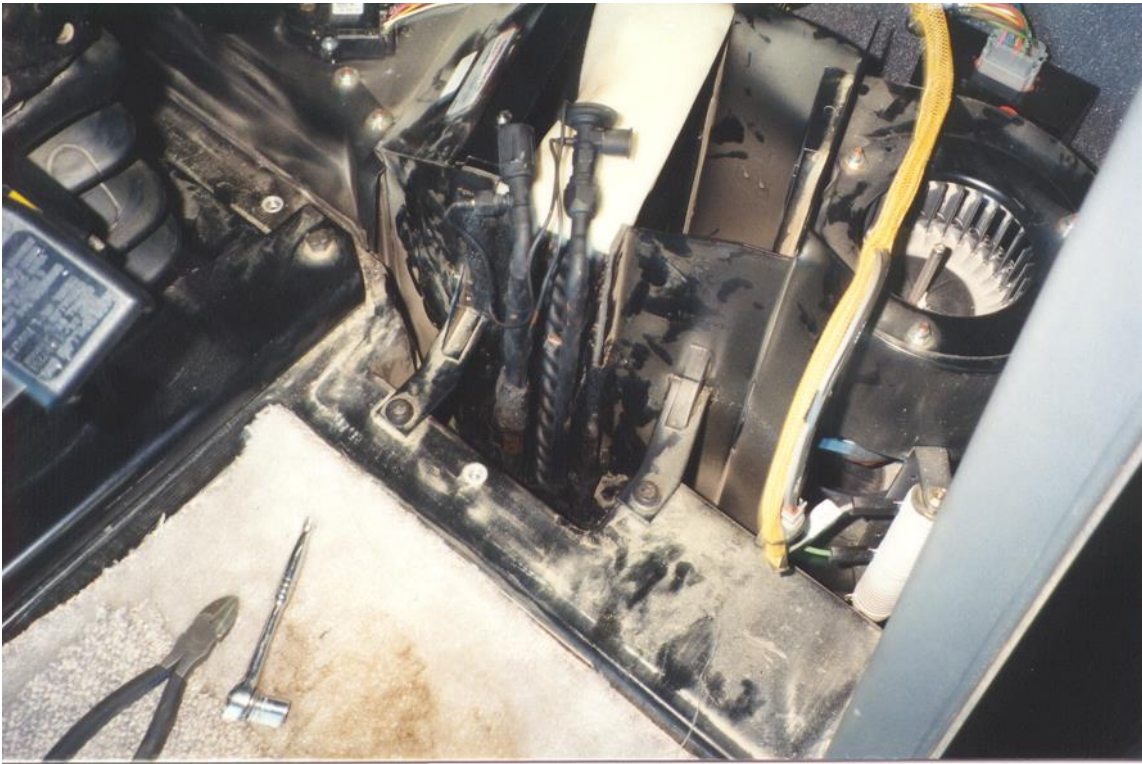

Evaporator in place alongside heater assembly.

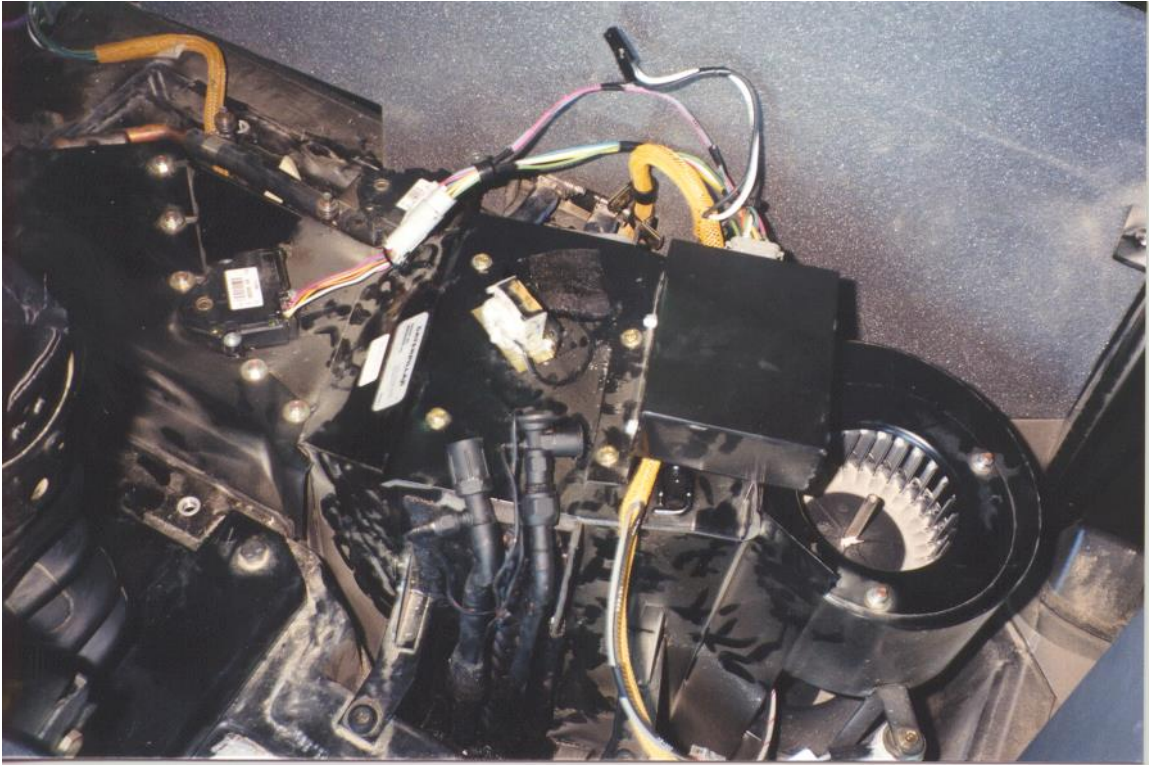

Evaporator box reassembled.



Evaporator box reassembled with hoses.



Hoses passing through hose plate (supplied) at rear of cab.

COMPRESSOR:

The compressor mounts on the right hand side of the engine and drives off of an open pulley on the crankshaft. The compressor mount bolts on the factory mount point just ahead of the injector pump.

- 1) Install the compressor mount.
- 2) Install the compressor onto the mount.
- 3) Install belt and tighten.

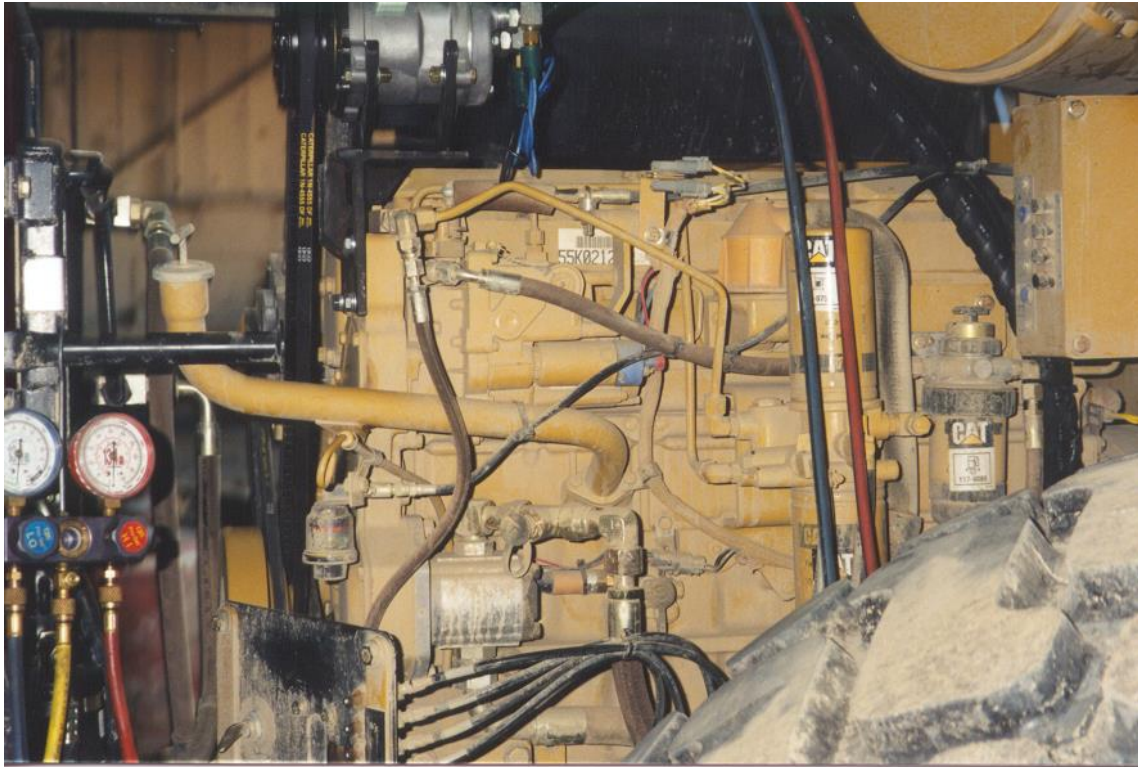

Compressor in place showing line runs.

CONDENSER:

The condenser mounts across the face of the rad just above the oil cooler.

1. Slide the condenser and frame in across the face of the rad above the oil cooler.
2. Mark the four mounting holes on the flange of the rad frame and drill 3/16" holes.
3. Tap the holes for 1/4" x 20 NC.
4. Bolt the condenser in place using the 1/4" x 1" bolts and hardware provided.

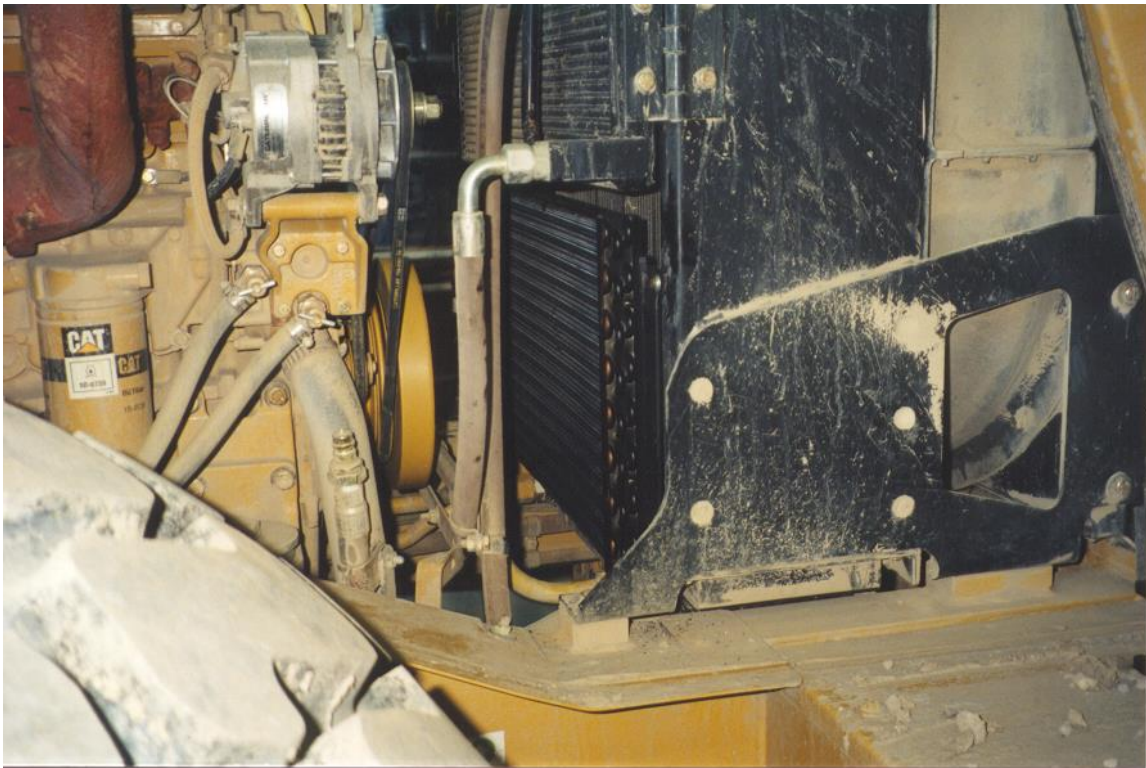

Condenser as viewed from left side.



Condenser as viewed from right side.

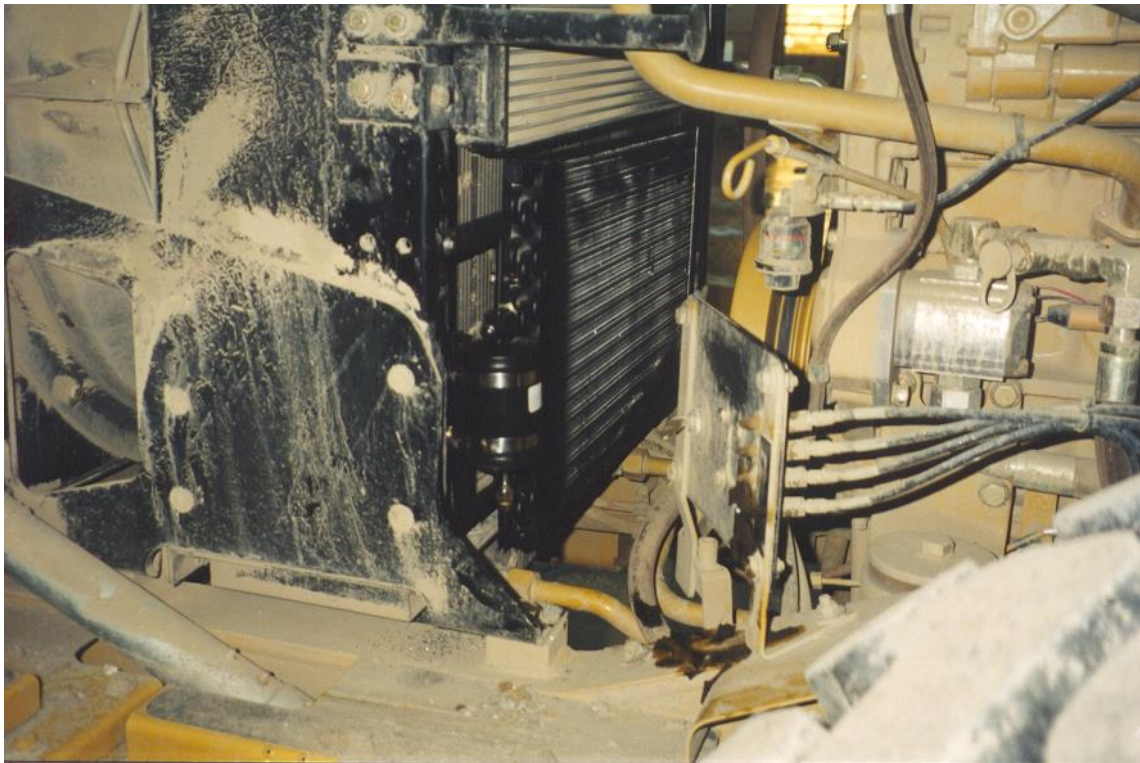

Condenser assembly with drier viewed from right side.

ELECTRICAL:

Mount the thermostat on the evaporator cover somewhere near the blower motor. Find the clutch wire running off the blower switch and cut the wire out of the bundle. Extend the wire with enough length to reach the thermostat terminal. Crimp on a female spade connector and install the wire to the thermostat. Connect the 14ga black clutch wire to the other terminal on the thermostat and route it down out of the heater compartment and along with the 5/16" hose. At the pressure switches, connect the clutch wire to the first press switch lead. Connect the other lead off the first switch to one lead of the second switch. Connect the last lead to the clutch wire on the compressor using a male and female spade connector.

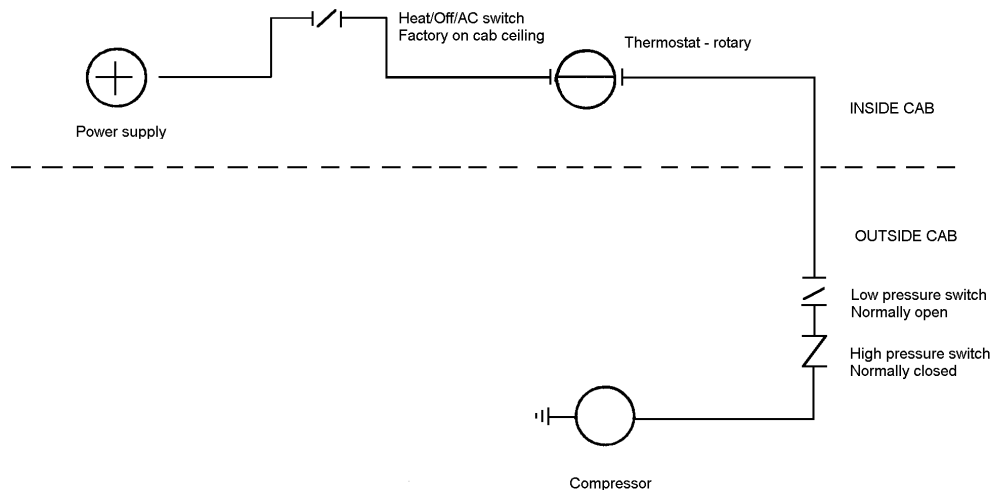

Refrigerant Flow Pattern in a Standard Air Conditioning System

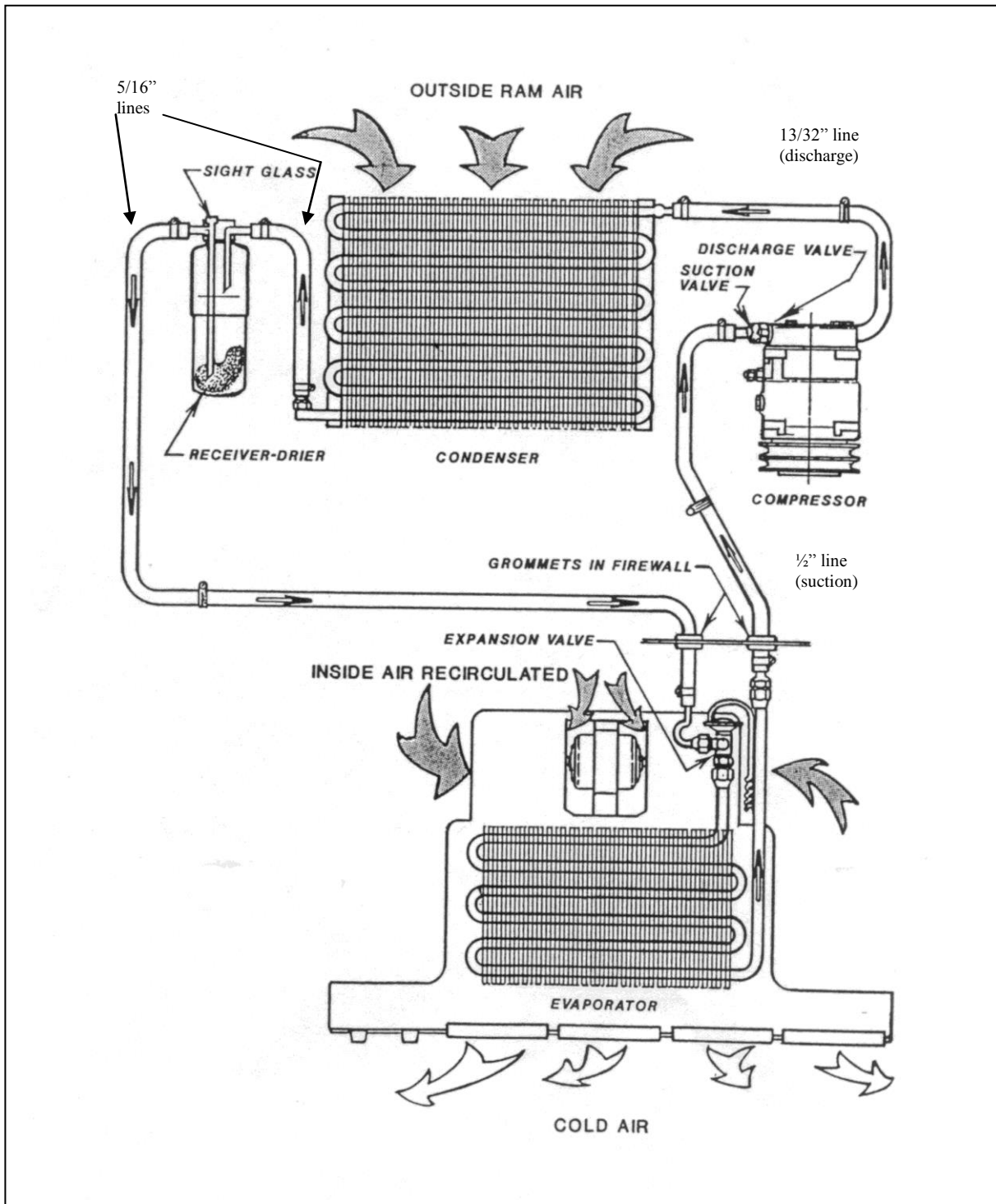

Thermostat Setting Procedures

- 1) Thermostat types
 - a) preset
 - b) adjustable
 - a) A preset thermostat is adjusted to its specific cut in and cut out temperatures when manufactured and does not have a rotary adjustment for the operator.
 - b) An adjustable or rotary thermostat has been manufactured to a predetermined cut in and cut out temperatures, but it is also operator adjustable to achieve the desired comfort level.

Both types of thermostats can have their factory settings adjusted by turning the setting screws on the body of the thermostat. One body type has the setting screws mounted externally and labeled for direction of rotation. The other body type requires the removal of the plastic end plate to expose the set screw.

- 2) Thermostat probe location: The location of the thermostat probe in an evaporator coil can be very important to achieve the maximum cooling potential of the coil while also preventing coil freeze-up. There is no set location for the thermostat probe to be put that will be optimum for all systems, but several rules of thumb may be followed:
 - a) Insert the probe in the coldest area of the evaporator coil.
 - b) Insert the probe from the top of the coil down, if possible.
 - c) Make sure that at least the last 3" of the thermostat probe are in the coil.

To find the most likely area where the coil is the coldest, consider these factors:

- 1) Direction of air flow through the coil.
 - 2) The coil area likely to have the lowest air flow.
 - 3) The inlet locations of the refrigerant into the coil.
 - 4) The inlet of the hotter outside air into the coil area.
-
- 1) Usually the coldest side of the evaporator coil will be the air outlet side. Often the thermostat probe can be inserted between the last and second last row of tubes.
 - 2) The lower air flow area of the evaporator coil in most systems tends to be near either end of the coil. These areas will be colder
 - 3) The area of the coil that the refrigerant inlet tube(s) occupy should be the coldest part of the coil.
 - 4) If the system is equipped with an outside air intake, where and how that air is brought into the evaporator area can have a large effect on the coil temperature. If all the outside air is piped into the evaporator in one area, that area will be considerably warmer in hot weather.

By looking at all these different factors, the area of an evaporator coil most likely to be the coldest can be determined.

Once the probe is inserted, the A/C system needs to be tested. Run the system to ensure that the thermostat is cycling the compressor off at the appropriate temperature. A core temperature ranging between 25° and 30° F should cause the thermostat to cycle off. The air temperature at the vent outlet closest to the evaporator coil should be between 38° F and 45° F when the compressor cycles off.

If the thermostat doesn't cycle off after a reasonable cool down period, and the air outlet temperature has dropped below 40° F, the cut in and cut out settings should be adjusted until the compressor is cycling on and off regularly. Let the system run for a decent time period (at least 15 min) and then check the evaporator coil for any signs of freezing.

Aeroquip E-Z Clip Assembly Instructions

Step 1. Cut the hose to proper length with an appropriate cutting tool. Aeroquip's hand held hose cutter has been specially designed for cutting all non-wire reinforced hose, such as GH-134 Multi-Refrigerant hose. Be sure the cut is made square to the hose length.

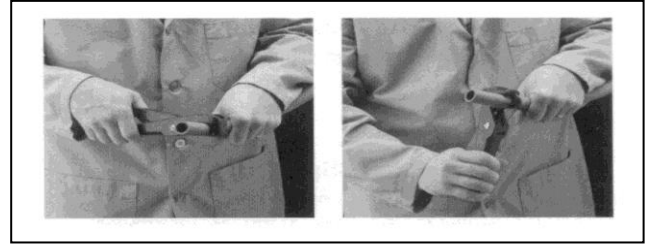

Step 2. Install two proper-sized clips onto the cut end of the hose. Orientation of the clips does not affect the performance of the connection. However, for ease of assembly, both clips should have the same orientation. NOTE: Failure to slide the clips over the hose at this time will require the clips to be stretched over the hose or fitting later. This may permanently damage the clip.

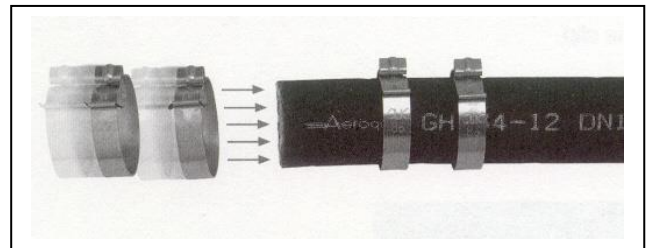

Step 3. Lubricate the nipple with a generous amount of the refrigeration or A/C system's compressor lubricating oil. This MUST be done to lower the force of nipple insertion.

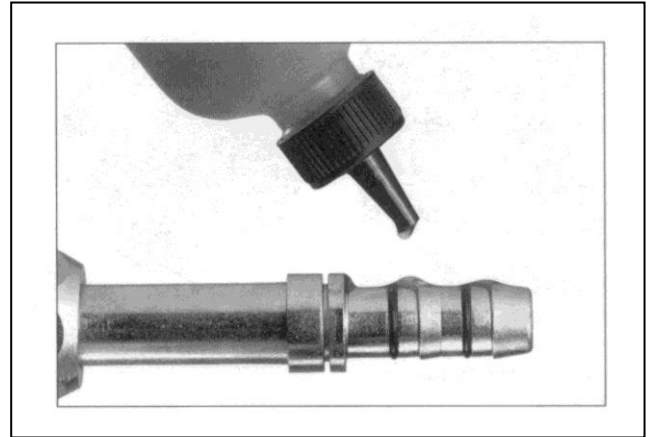

Step 4. Insert the nipple into the hose. To ensure that the nipple is fully inserted, check the gap between the cut end of the hose and the shoulder on the nipple. Care should be taken to avoid kinking or other damage to the hose during nipple insertion. NOTE: Be sure to wipe excess oil from the nipple and hose.



Step 5. Snap the cage into the groove on the nipple. The arms should extend over the hose length. When the cage has been correctly installed in the cage groove, the cage will be able to rotate in the groove. This step **MUST** be performed to ensure:

1. The clips will be located over the O-rings on the nipple.
2. The connection will be compatible with the connection's pressure rating.

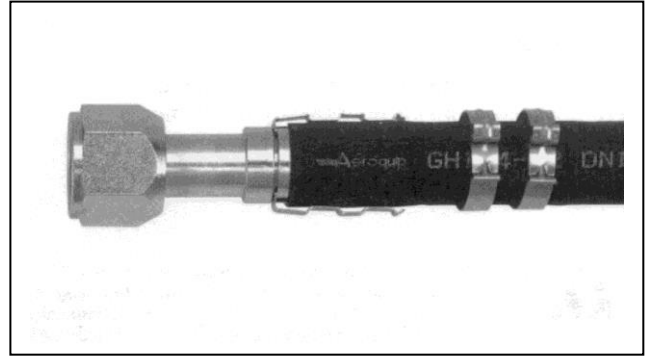

Step 6. Slide the clips over the cage arms and into the channels on each arm.

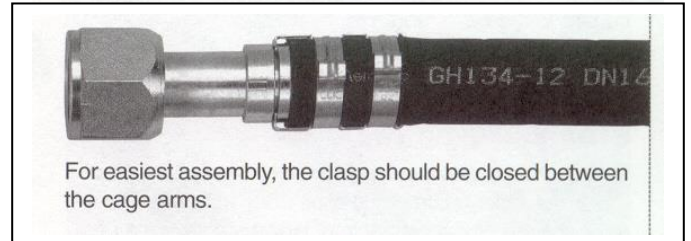
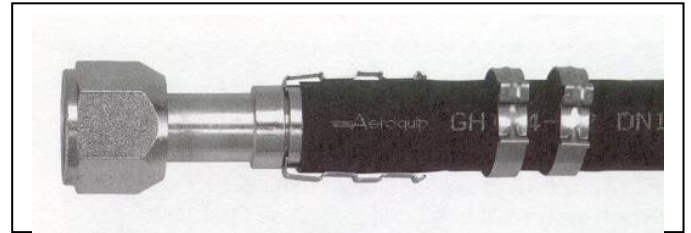

Step 7. Use the pliers to close the clips. The pliers should be positioned squarely on the clip connection points and should remain square during the closing of the clip.

NOTICE: E-Z Clip components should not be reused.

